



think fresh!™



FLAVIA® Creation 400™

USER GUIDE UK



www.myflavia.com

CONTENTS

	PAGE
Safety Precautions	1
Brewer Layout	2
Setting up your FLAVIA® Brewer	2, 3, 4, 5
Preparing a FLAVIA® Beverage/Drink	6
Daily care of your FLAVIA® Brewer	7
Weekly care of your FLAVIA® Brewer	8
Draining your Brewer.....	9
Beverage/Drink Options	9
Troubleshooting	10,11
Safety & Installation Guidelines	12,13, 14

SAFETY PRECAUTIONS

GENERAL USE

In order to prevent harm or injury to those using the appliance or to any other persons and/or property, please be sure to read the following safety instructions.

- ⊘ **Place out of the reach of children. Children and persons unfamiliar with the equipment should only use it under supervision.** *Not observing these precautions may cause burns, electric shock and other injury.*
- ⊘ **Never place outside.** *This system is for indoor use only.*
- ⊘ **Never attempt to change the specification or modify systems in any way.** *Any attempt to do so may result in fire or injury. If in need of assistance, please contact customer service or your local FLAVIA® supplier.*
- ⓘ **Ensure access to the rear of the system can be achieved easily to allow isolation of the electrical and water supply.**
- ⊘ **Under no circumstances should you attempt to perform any servicing or repairs on this system.** *Inexperienced persons may cause injury or malfunction. Always call customer service or your local FLAVIA® supplier.*
- ⓘ **Do not immerse in water.**
- ⓘ **Only clean specified areas as instructed.**
- ⓘ **Do not install where a water jet could be used.**
- ⊘ **Supervise if any children, aged or infirm persons are using the system.**
- ⊘ **Never use without placing a cup under the water outlet.** *Hot water may get caught in the lid and drip tray causing burns.*
- ⊘ **Drain water tank and keep upright for transportation and storage.**

ELECTRICAL SUPPLY AND CORD

- ⊘ **Never do anything that might cause damage to the cord or plug, (such as modify them, place hot or heavy objects on them, bend them, stretch them, or twist them).** *If the appliance is used when damaged, electrical short circuit or fire may result. If in need of repair please contact your local FLAVIA® Customer Service Officer.*
- ⓘ **Clean the plug from dust regularly.** *A build-up of dust on the plug will attract condensation, which could cause cable damage resulting in fire. Remove the plug and clean with a dry non-conductive cloth.*
- ⓘ **The appliance must be earthed.** *Failure to do so may result in electric shock.*
- ⓘ **Make sure the plug is correctly inserted in the power socket.** *An unsafe plug may cause electric shock or generate heat resulting in fire. Do not use a damaged plug or loose power socket.*
- ⓘ **230V socket must not be used with other appliances.** *When used alongside other appliances, heat generated may result in fire.*
- ⊘ **Never plug or unplug the appliance with wet hands.** *This may result in electric shock.*

BREWER LAYOUT

EXTERIOR

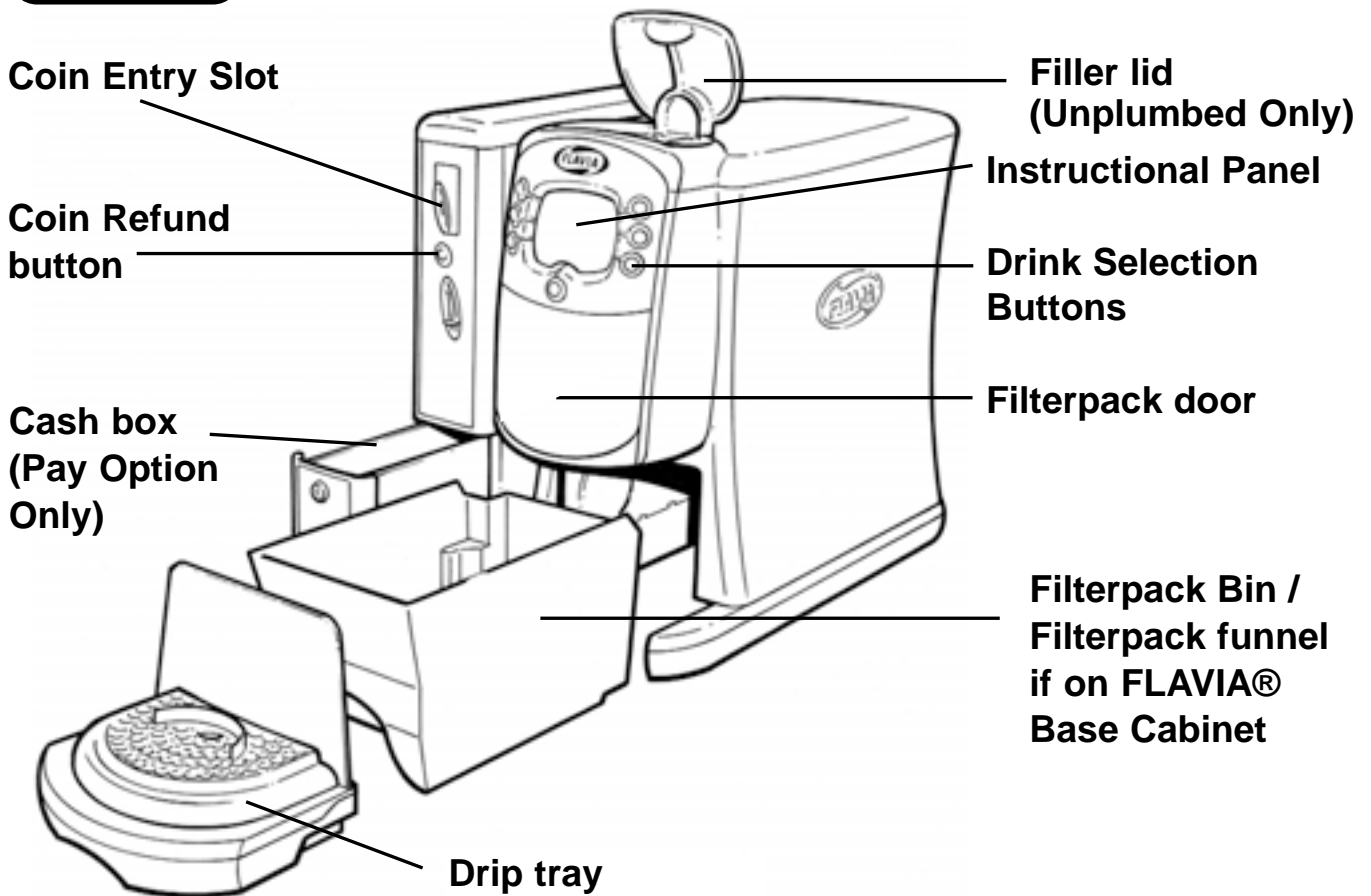

ENG

SETTING UP YOUR BREWER

SWITCHING ON

1. Plug your FLAVIA® brewer in
2. Switch on using **ON/OFF** switch at back

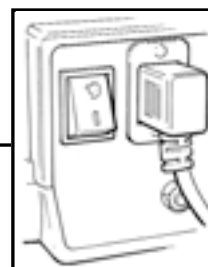

FILLING WITH WATER

1. Enter operator menu (push and hold bottom left and right buttons) (Ref. A)
2. Enter password (default password: press top right button 4 times) (Ref. B)
3. Operator menu (Ref. C)

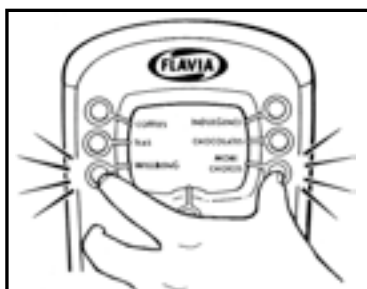

(Ref. A)

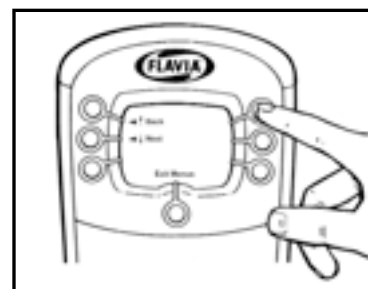

(Ref. B)

SETTING UP YOUR BREWER

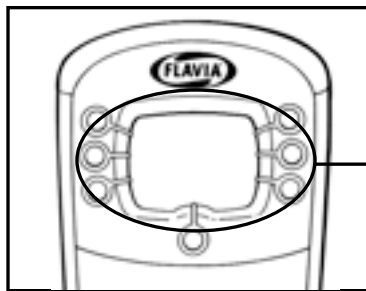

(Ref. C)

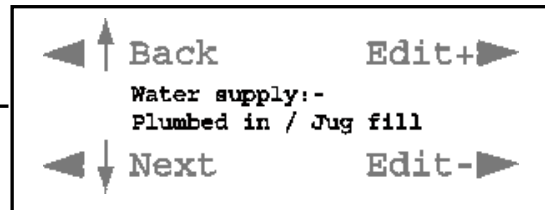

4. Press back / next to select 'water supply'
5. Select plumbed-in or jug filled by pressing Edit + / -
6. Press Exit menus
7. →

Fill with water

Plumbed-in - Connect to mains water at back of brewer

Jug filled - Fill via filler lid
Use **COLD** water only to fill.



PRIMING (INSTALL ONLY)

Note: You cannot brew drinks if you have not primed the brewer first! The priming cycle fills the boiler with water. After this, your brewer will be ready for use.

1. Enter operator menu (as per steps 1 - 2 in filling section)
2. Press back / next to select 'Hot tank control'
3. Press prime to activate
4. Wait until message 'tanks primed' appears
5. Press Exit menus

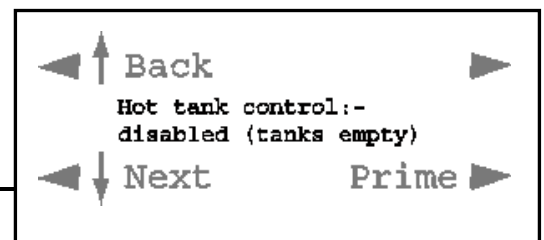

Once water is added, the display will read **"WATER HEATING"** and the brewer is now ready for use.

CONFIGURING ENERGY SAVING MODE

In order to conserve energy the brewer can be configured to switch to standby mode after a specified time of inactivity. To configure the energy saving mode:

1. Enter Operator menu (push and hold bottom left and right buttons) (Ref. A)
2. Enter password (default password: press top right button 4 times) (Ref. B)
3. Press back / next to display the 'standby timeout (mins)' screen (Ref. D)
4. Set time period for brewer to enter standby in minutes by pressing Edit +/-
5. Press Exit menus

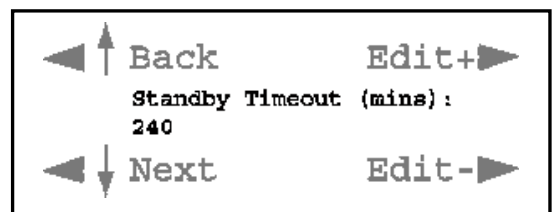

(Ref. D)

(Ref. E)

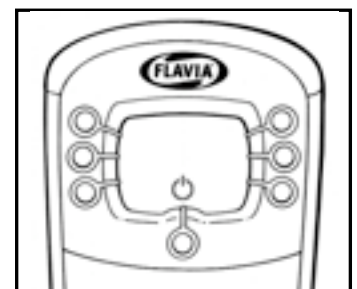

If brewer is inactive for the specified time it will enter standby mode. In this mode the boilers will be switched off and the display will show a standby symbol (Ref. E)

SETTING UP YOUR BREWER

SETTING OPERATOR PASSWORD

The operator menu of the brewer can be password protected to prevent unauthorised access. To set a new password:

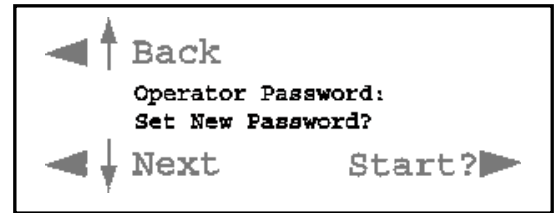

(Ref. F)

1. Enter operator menu (push and hold bottom left and right buttons) (Ref. A)
2. Enter default password (press top right button 4 times) (Ref. B)
3. Press 'Start?' (Ref. F)
4. Enter a unique 4 digit password using the six buttons on the left and right of the display (Ref. G)
5. Confirm the 4 digit password to reset the menu screen and activate the new password
6. Press Exit menus

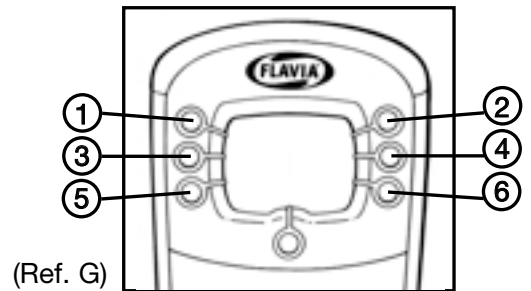

(Ref. G)

Notice

- If a password is lost or forgotten it can only be reset by a service engineer
- Changing the password is not recommended unless the brewer is being used in conjunction with a paypod to prevent the brewer being switched to 'Free Vend'
- Please contact customer service or your local FLAVIA® supplier in the event of a lost or forgotten password

SELECTING YOUR CUP STAND

Choosing the right cup stand will mean your brewer stays cleaner for longer – the closer the rim of the cup is to the bottom of the filterpack door, the cleaner your brewer will be. Two cup stands are supplied. Please fit the appropriate cup stand as follows:

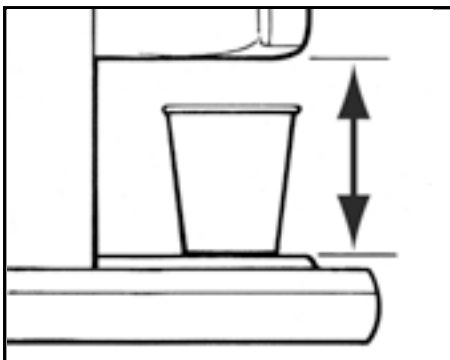

Low Level

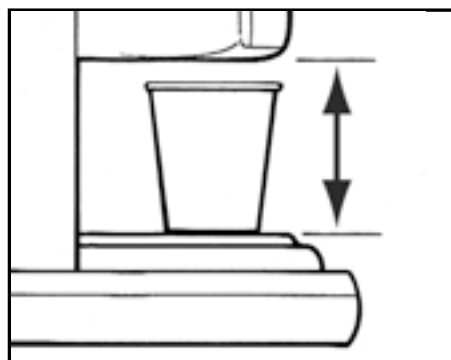

High Level

Low Level :  for cups between 94mm and 104mm tall
High Level :  for cups up to 94mm tall

SETTING UP YOUR BREWER

SELECTING YOUR CUP

1. The use of FLAVIA® paper cups is recommended. Alternative cups may be used providing they are of similar proportions to ref. H and weigh a minimum of 5g
2. Crockery may be used providing it is of similar shape and proportions to ref. H
3. Use of cups that do not meet the recommended criteria may result in overflow or mess creation
4. For further advice on cups and crockery suitable for use with your brewer please contact customer service or your local FLAVIA® supplier

The use of FLAVIA® paper cups is recommended. Alternative cups may be used providing they are of similar proportions and weigh a minimum of 5g

Caution

Please be aware that the minimum cup size for use with a large drink to avoid overflow is 200ml (7floz UK)

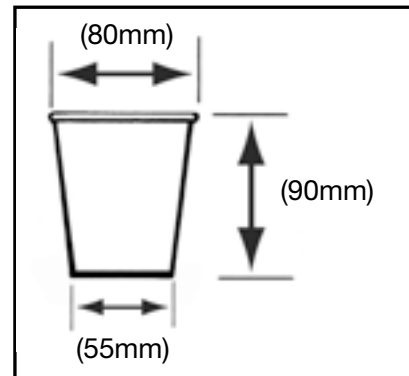

(Ref. H)

Minimum weight 5g

PREPARING A BEVERAGE/DRINK

ENG

1 Insert coins (pay option only)

Notice

No change is given. "Insert coins" will stop flashing once money is sufficient

2 Place cup centrally on cup stand and push back



Caution

The minimum cup size for use with a large drink to avoid overflow is 200ml (7fl oz UK)

3 Select category

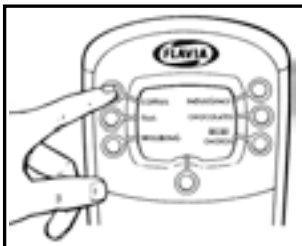

Select drink

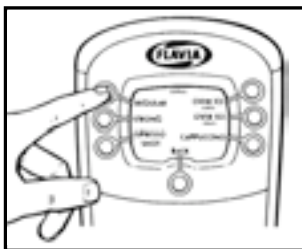

4 Insert filterpack

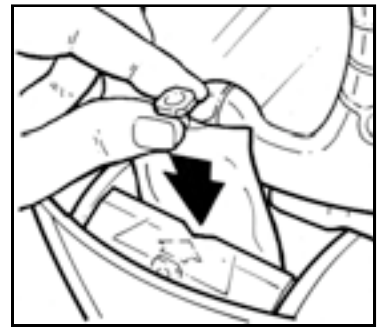

5 Close door

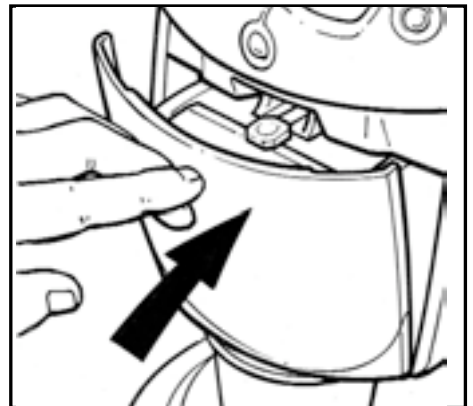

6 While your drink is being freshly filtered / brewed into your cup, keep hands clear.

Notice

For 2-pack drinks follow screen prompt and repeat stages 4, 5 6.

LARGE/TRAVEL MUG FACILITY

- To vend your drink into a large mug
- Remove drip tray

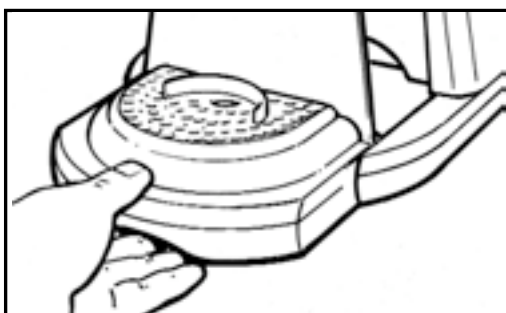

- Place your mug and follow steps 3 to 6 as normal

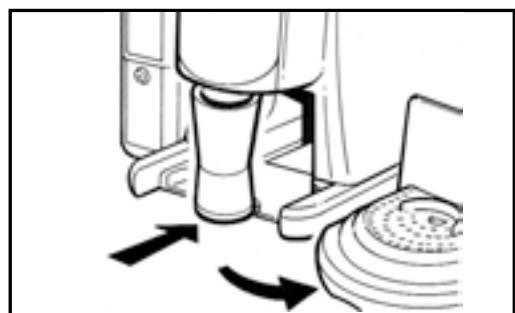

DAILY CARE

EMPTYING THE DRIP TRAY

1. Lift out and empty drip tray. CAUTION – CONTENTS MAY BE HOT
2. Separate drip tray and cup stand
3. Clean them in warm soapy water, wipe area left by drip tray
4. Reassemble and replace carefully

WARNING - HANDLE DRIP TRAY AS REF. A

Notice • The brewer does not tell you when the drip tray is full so make sure you check it regularly

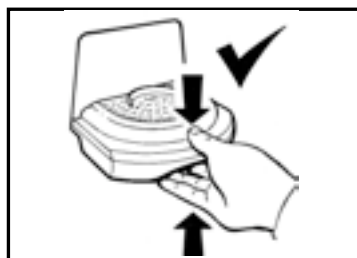

Ref. A



EMPTYING THE FILTERPACK BIN

1. Remove drip tray
2. Pull bin forward
3. Empty filterpack bin
4. Clean bin in warm, soapy water
5. Replace bin
6. Replace drip tray



Notice

- Take care when removing filterpack bin
- The act of removing the bin resets the bin counter - Always empty the bin if removed

Notice

- If filterpack bin fills right up, the “check bin” message will be displayed
- If your FLAVIA® brewer is on a base unit, the “check bin” message will not be displayed

REFILLING WITH WATER (Manual fill only)

1. Lift the filler lid
2. Fill with water
3. Maximum fill level reached when the red float cap pops up
4. Close the filler flap

Notice

- Only use cold water when refilling
- Take care not to overfill tank
- If tank runs out before water is refilled, the display will read “ADD WATER”
- If tank is overfilled water will flow out from underneath filterpack door and into drip tray*

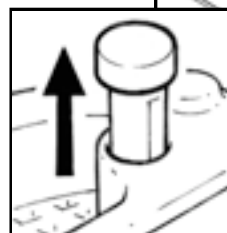

* Only applies to models of brewer with an air duct fitted

WEEKLY CARE

GENERAL CLEANING

Use a damp cloth to wipe the outside surfaces and the areas that are exposed inside.



Notice

- Do not use strong detergents and take care not to get soapy water into the water tank as this will affect the drink taste

CLEANING THE WATER FILLER FUNNEL

1. Open filler lid
2. Remove filler funnel assembly
3. Clean them
4. Rinse thoroughly (so no soap gets into tank)
5. Replace
6. Close the filler flap

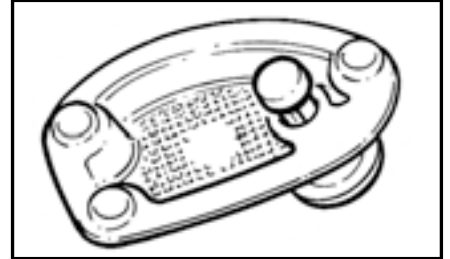
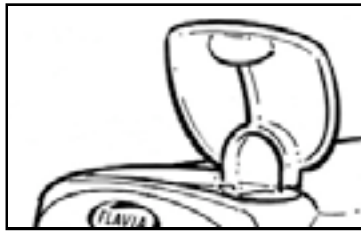

CLEANING THE FILTERPACK DOOR

1. Grip bottom of filterpack door
2. Use other hand to steady the brewer.
3. Pull sharply from bottom towards you
4. Wash in warm soapy water and rinse thoroughly
5. Wipe sides of area where door was
6. Replace door – **Top first**
7. Push bottom of door until you hear a 'CLICK'

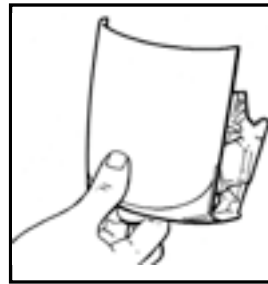

CLEANING THE CUP DETECT AND AIR DUCT

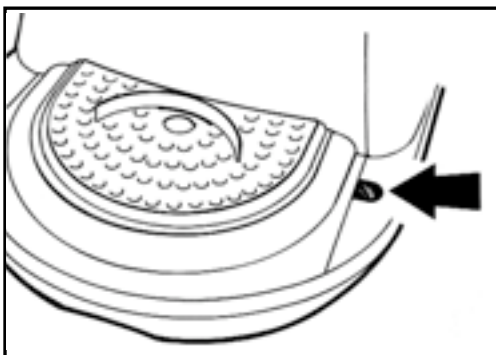

Ensure sensor is wiped clean and not obstructed

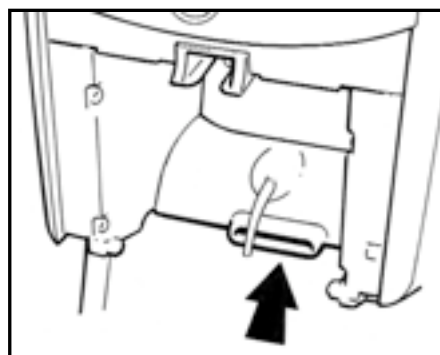

Ensure air duct is clean and free of debris

Notice

- Remove filterpack door to access air duct

SANITISING

- After cleaning, sanitise surfaces with a non-chlorine based anti-bacterial wipe or solution.
- Avoid scented products, as this will affect the drink taste.

DRAINING YOUR BREWER

Draining is recommended before moving the brewer.



Notice • Make sure brewer is turned off

1. Remove drip tray and bin
2. Remove bung. CAUTION – WATER MAY BE HOT
3. Allow all water to drain out
4. Replace bung fully
5. Clip drain tube back into place

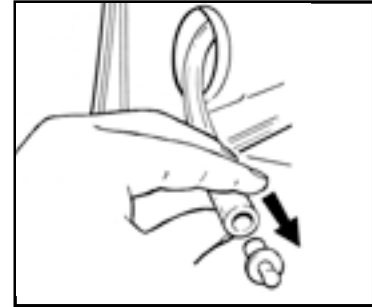
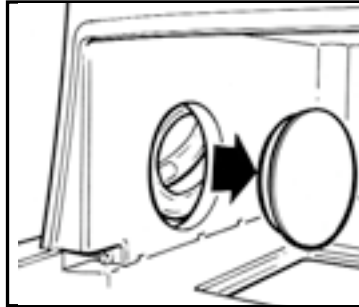

BEVERAGE/DRINK OPTIONS

COLLECTING AUDITS

1. Enter operator menu (push and hold bottom left and right buttons) (Ref. A – page 2)
2. Enter password (default password press top right button 4 times) (Ref. B – page 2)
3. Display will say 'Total Cups'
4. Press 'Next' Display will say 'Free 2-pack Cups'
5. Press 'Next' Display will say 'Free 1-pack Cups'
6. Press 'Next' Display will say 'Total Packs'
7. Press 'Next' Display will say 'Interim Total Packs' This can be set to zero
8. Press 'Next' Display will say 'Interim Total Cups' This can be set to zero

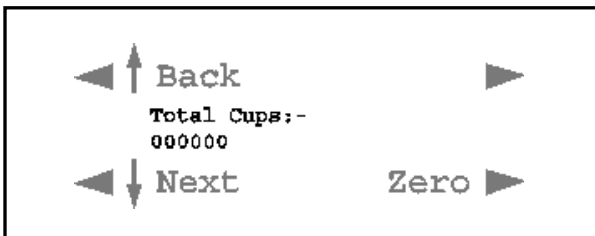

TROUBLESHOOTING

The sophisticated design of your FLAVIA® brewer makes it very unlikely that anything will go wrong. However, if faults do develop, you can resolve many of them yourself.

ENG

PROBLEM	REASON	SOLUTION
"EMPTY BIN" message flashes	Filterpack bin is full	Pull out and empty the filterpack bin. Clean bin if necessary. Replace bin
"CHECK BIN" message flashes	Bin has not been returned properly	Make sure filterpack bin is returned If message still stays on, contact customer service or your local FLAVIA® supplier
"ADD WATER" message flashes	Brewer needs to be filled	<u>MANUAL FILL</u> Ref. pages 2 / 3 <u>PLUMBED FILL</u> Check water supply is turned on, and that delivery pipe is not kinked. Ref. pages 2 / 3
"WATER HEATING" message flashes	The water is heating	If message stays on for more than 20 minutes, please switch off brewer and call customer service or your local FLAVIA® supplier
Spillage around the brewer	The drip tray may have overflowed.	Remove, empty and replace drip tray ref. page 5. CAUTION – WATER MAY BE HOT
Cups do not fit	Wrong height cup stand	Two cup stands are provided with the brewer. Ref. page 4
Filterpack door will not close	Filterpack door not re-assembled properly	Remove and replace filterpack door (check under Weekly Care – Cleaning Filterpack door for how to do this)

TROUBLESHOOTING

PROBLEM	REASON	SOLUTION
<p>No messages on display</p>	<p>Brewer has been switched off at back</p> <p>Brewer disconnected at socket</p>	<p>Switch brewer on using the ON/OFF switch at back. Ref. page 2</p> <p>Put plug back into socket and switch on at socket</p> <p>If problem recurs, please call customer service or your local FLAVIA® supplier</p>
<p>“CALL OPERATOR” message flashes</p>	<ul style="list-style-type: none"> • “PACK DOOR TIMEOUT” • “PACK INJECT TIMEOUT” • “PACK EJECT TIMEOUT” 	<p>Enter Operator Menu ref. pages 2, then press ‘Exit Menus’ to reset</p> <p>If problem recurs, please call customer service or your local FLAVIA® supplier</p>
	<ul style="list-style-type: none"> • “TANK FILLING TIMEOUT” • “BUTTON STUCK DOWN” • “SELECT PAYMENT SYSTEM” 	<p>If your brewer is intended to be jug filled, then change the ‘Water Supply’ in ‘Operator Menu’ ref. pages 2/3, if problem recurs, please call customer service or your local FLAVIA® supplier</p> <p>Press all selection buttons to check movement. If problem recurs, please call customer service or your local FLAVIA® supplier</p> <p>The ‘Free Vend’ menu is set to ‘Disabled’, Enter ‘Operator Menu’ ref pages 2. Press ‘Edit’ to enable ‘Free Vend’. If problem recurs, please call your customer service or your local FLAVIA® supplier</p>

SAFETY AND INSTALLATION GUIDELINES

We at Mars Drinks are committed to safety in all aspects of our product design, manufacture, installation and service.

SYSTEM APPROVALS

This system has been designed and manufactured in accordance with European legislation relating to Safety and Electromagnetic Compatibility (EMC).

WARNINGS AND GUIDANCE

These warnings are provided in the interests of safety. Please read them carefully and ensure anyone who is involved with routine cleaning and loading also reads them.

- Ensure that the machine is kept on a level surface.
- This system is for indoor use only. Never place outside, or allow to freeze. If freezing occurs contact customer service or your local FLAVIA® supplier.
- It is dangerous to change the specification or modify the systems in any way
- Ensure access to the rear of the system can be achieved easily to allow isolation of the electrical and water supply
- Under no circumstances should you attempt to perform any servicing or repairs on this system. Inexperienced persons may cause injury or malfunction. Always call customer service or your local FLAVIA® supplier.
- Do not immerse system in water
- Only clean in specified areas as instructed
- Do not install where a water jet could be used.
- Supervision is required if the system is to be used by young children, aged or infirm persons
- This system contains electronic circuits. **Do not flash test.**
- Observe recommendations relating to regular inspection and testing of this system under the “U.K. Electricity At Work” section
- An ambient temperature range of +5°C to +30°C is recommended for system location

IMPORTANT NOTES

- **The system is flash tested before it leaves the manufacturing premises. Repeated flash testing can damage insulation.**
- **This system contains electronic components. Other tests that are available on portable appliance testers are *Load Test*, *Earth Leakage Test*, and *Output Test*. These tests are not required.**

Notice • DO NOT FLASH TEST THIS EQUIPMENT

ELECTRICAL CONNECTION

- If the plug is damaged it should be removed from the voltage supply, cut off and disposed of carefully. **NEVER ATTEMPT TO RE-USE.**
- If the mains cord or plug is damaged never attempt to replace; contact customer service or your local FLAVIA® supplier.
- Never attempt to plug in a cut-off plug into a mains socket. Such action may present a shock hazard.

SAFETY AND INSTALLATION GUIDELINES

INSTALLATION OF YOUR FLAVIA® BREWER

Brewer Dimensions

Height - 432mm

Width - 252mm

Depth - 517mm

A gap of 60mm is required behind the Brewer if it is to be plumbed in.

Electrical Supply

It is important that you have a power supply ready so that we can install your new system quickly and efficiently.

You will need to supply a suitable switched electrical supply to meet the requirements for isolation of electrical equipment.

i.e. A 13 Ampere supply requires 13 Ampere switched socket or a lockable isolator.

Only use a 230V AC single phase power supply.

Use only one system per socket and ensure it is earthed.

Your system comes supplied with a mains lead 2 metres in length. Only this lead should be used, no old leads should be re-used.

Notice

- If you are unsure about any installation requirements, consult an electrician and/or a plumber.

Plumbed Systems

A plumbed system will need a mains drinking water supply.

i.e. A brass stopcock to BS1010 standard with a 15mm compression outlet or a brass stopcock with a 3/4 inch BSP male outlet.

Water pressure must be between a maximum of 0.7 MPa (7 bar, 100 psi) and a minimum of 0.1 MPa (1 bar, 14.5 psi).

Brewer to be connected to cold water supply only.

Your system is supplied with a flexible mains water hose 2 metres in length. This hose should be used, no old hose-sets should be re-used.

Notice

- Do not use water that has come from a water softener or contains sodium.
- Install in accordance with local plumbing regulations.
- Jointing compound should not be used in the water supply to the system, as this will affect the drink flavour, only use PTFE tape.
- Do not locate the water supply above the mains power socket.
- We draw your attention to the requirements of the Water Supply (Water Fittings) Regulations 1999.

Installing

Please contact customer service or your local FLAVIA® supplier for your brewer to be installed.

SAFETY AND INSTALLATION GUIDELINES

UK SPECIFIC REQUIREMENTS

- Your system is supplied with a moulded 13 Ampere fused plug.
- If the fuse needs replacing only use an ASTA approved BS1362 13 Ampere cartridge fuse.
- Always re-fit the fuse cover.
- If the fuse cover is lost or damaged a replacement can be obtained by contacting customer service or your local FLAVIA® supplier. Ensure the replacement cover is the same colour as that which is visible on the pin face of the plug.
- Never attempt to use the plug without the fuse cover being fitted.

UK ELECTRICITY AT WORK REGULATIONS 1989

We recommend that the following tests are performed on the system on an annual basis by a suitably trained person using a Portable Appliance Tester following the manufacturer's instructions.

TEST

**Earth Bond Test
Insulation Resistance**

RECOMMENDED LEVEL

**Less than 0.1Ω (including mains lead)
Greater than 2 MΩ.**

- The mains plug lead and socket should be checked weekly for any signs of damage.
- All test results should be recorded and retained for future reference including the date performed, who performed them and the next test date.
- If any test or inspection fails do not connect the system. Call customer service or your local FLAVIA® supplier immediately.

